



## SureFly Ignition Module

# SIM6C

6 Cylinder Continental Magneto Replacement

# INSTALLATION INSTRUCTIONS

Document No. SF1003, Revision D

### Revision History

Revision:	Date:	Description:	Approved By:
IR	05/21/2018	Initial release.	JDH
A	06/18/2018	Added page numbers, revised section 3, included drawings SIM6C & SIM6C-INSTALL.	JDH
B	07/26/2018	Reformatted for clarity & added illustrations.	RVC
C	03/30/2020	Added Section 2.16 & 3.4 b), revised Section 2.12.	RVC
D	02/09/2023	Revised to include instructions for dual SIM installations.	RVC

# Contents

---

Contents .....	2
1. Installation Overview .....	3
1.1. General Description: .....	3
1.2. Operation: .....	4
1.3. Technical References: .....	4
2. Step-By-Step Installation Instructions .....	5
2.1. Eligibility Determination:.....	5
2.2. Power Requirements: .....	5
2.3. Component List: .....	7
2.4. Preparation:.....	7
2.5. Remove Magneto:.....	8
2.6. Remove & Inspect Drive Interface: .....	8
2.7. Configure SIM: .....	8
2.8. Set Engine to #1 TDC: .....	10
2.9. Install Drive Interface: .....	10
2.10. Internally Time SIM: .....	10
2.11. Mount SIM to Engine: .....	11
2.12. SIM Timing Check:.....	11
2.13. Install Ignition Harness:.....	11
2.14. Manifold Pressure Connection:.....	12
2.15. Turbocharged, Turbo-normalized or Supercharged Engines:.....	12
2.16. Wiring: .....	12
3. Post-Installation .....	13
3.1. Spark Plugs & Harness:.....	13
3.2. Final Inspection: .....	13
3.3. Pre-Operational Check: .....	14
3.4. Operational Check: .....	14
3.5. Airframe Installation & Electrical Power:.....	14
4. Documentation .....	14
4.1. STC Permission Letter: .....	14
4.2. FAA Form 337:.....	14
4.3. Maintenance Log:.....	14
4.4. ICA: .....	14

# 1. Installation Overview

---

## 1.1. General Description:

The **S**ureFly **I**gnition **M**odule (SIM) is a magneto replacement for Continental & Lycoming aircraft piston engines.

The SIM is designed to use existing aviation spark plugs gapped up to .035”.

The SIM is designed to use a “Slick” style ignition harness. If replacing a “Slick” magneto, the existing harness may be re-used. If replacing any other magneto, or for a new installation, an approved “Slick” style ignition harness is needed. Although not required, SureFly recommends installing a new harness when installing a SIM.

The SIM is designed to use existing magneto-to-engine drive gears and interfaces.

The SIM operates in one of two modes:

1. Variable timing mode – timing advances based on RPM and manifold absolute pressure (MAP), or
2. Fixed timing mode – engine data-plate timing maintained throughout operational range.

**UNLIKE A MAGNETO, THE SUREFLY SIM IS TIMED (SYNCED) TO #1 CYLINDER COMPRESSION STROKE TDC (0°).**

The SIM references #1 cylinder compression stroke TDC (0°) and advances timing within the unit based on its dip switch setting.

Each SIM requires a constant, external supply of 8.5 – 30VDC power to operate.

**This manual covers only the installation of one or more SIMs onto an engine only.**

**THIS STC DOES NOT INCLUDE AUTHORITY TO CONNECT A SUREFLY IGNITION MODULE TO AIRFRAME ELECTRICAL POWER. ELECTRICAL POWER REQUIREMENTS WITHIN THIS STC ARE NOT TO BE CONSTRUED AS PERMISSION TO MODIFY THE ELECTRICAL SYSTEM OF AN AIRCRAFT.**

SureFly’s Airframe Installation Instructions SF2001 provides authority for connecting a SIM-modified engine to an airframe electrical system. For information on SureFly’s airframe STC please see [www.surefly.aero/airframe](http://www.surefly.aero/airframe)

## 1.2. Operation:

The SIM operates like a magneto.

When the SIM is configured to operate in variable timing mode, the SIM will only advance beyond fixed engine timing under specific RPM and MAP conditions. Up to 38° of advance may be reached by the SureFly SIM.

To operate the SIM in variable timing mode, the engine onto which the SIM is installed must comply with the following requirements:

1. Normally aspirated,
2. Have Cylinder Head Temperature (CHT) monitoring capability,
3. Use minimum of 100-octane low lead aviation fuel.

If the installation does not have equipment to monitor cylinder head temperatures, if the engine is equipped with a turbo or super charger, or if the engine operates on any fuel other than 100LL, you must configure the SIM for fixed timing mode.

SureFly recommends starting the engine on the SIM. The SIM provides a more accurately retarded spark than an impulse coupled magneto at low engine RPM. This alleviates the need for an impulse coupled magneto or supplemental starting equipment like "Shower of Sparks".

## 1.3. Technical References:

The following documents may be referenced during the installation of the SIM:

1. SureFly SIM6C Installation Instructions: SF1003 (this document),
2. SureFly Overview Drawing: SIM6C,
3. SureFly Hardware Kit Drawing: SIM6C-HW,
4. FAA Advisory Circular 43.13-1b Acceptable Methods, Techniques, and Practices.

Copies of these documents may be found at [www.surefly.aero/engine](http://www.surefly.aero/engine)

## 2. Step-By-Step Installation Instructions

---

### 2.1. Eligibility Determination:

Before commencing, you as the owner or installer must determine whether the SIM is approved for installation on the intended engine. SureFly's STC has an Approved Model List (AML) that shows eligible engines.

**FIRST:** Determine whether your engine is listed on SureFly's engine STC AML. A copy of the AML may be found at [www.surefly.aero/engine](http://www.surefly.aero/engine)

If your specific engine (entire model designation) is listed on the AML, you may proceed.  
If your engine is NOT listed on the AML, stop now and contact SureFly.

**SECOND:** Determine whether any previously installed STC's conflict with the installation of the SIM. Such might include:

1. FADEC systems,
2. Fuel STC's that allow the use of fuel other than 100LL,
3. Aftermarket turbo or super chargers.

If no conflicting STC's are found, you may proceed.

If any previously installed STC's may conflict with the installation of the SIM, stop now and contact SureFly.

### 2.2. Power Requirements:

The data herein prescribes only requirements for a SIM to operate safely. The requirements below **DO NOT constitute authority to connect a SIM to an aircraft electrical system, to install electrical devices or to modify the electrical system of an aircraft.**

Operating power requirements @ 2700RPM (w/ safety factor added in):

Model:	@ 14VDC	@ 28VDC
SIM6C	1.5A	0.75A

#### **For engines equipped with a single SIM:**

1. The first SIM on an engine must be powered directly from the primary aircraft battery, and
2. The primary aircraft battery must be 10-30V and be able to provide a 10A peak current demand to the SIM.

### **For engines equipped with dual SIM's:**

1. The second SIM on an engine must be powered from a separate battery independent of the primary aircraft battery, and
2. The second battery must be 10-30V with a minimum capacity of 2Ah and be able to provide a 10A peak current demand, and
3. A load analysis must be calculated to ensure the ability of the second battery to operate the second SIM, and all other essential loads connected to it, for a minimum of 60 minutes upon the loss of the primary electrical system, and
4. The aircraft must have a visual means to warn the flight crew of primary electrical system fault, and
5. The instrument panel must be placarded with a warning to prohibit the flight crew from operating the aircraft with low battery voltages or an inoperative charging system, and
6. **For Single Engine Aircraft:** the second battery must be configured in one of the following forms:
  - a. **FAA Approved Backup Battery System:** The backup battery system must be connected to the second SIM in a manner such that the failure of the aircraft primary electrical system would not affect the backup battery system, and vice versa. The following requirements must also be met:
    - i. The backup battery system must provide the flight crew a pre-flight method of ensuring sufficient capacity is available to power the second SIM for a minimum of 60 minutes.
    - ii. The backup battery system must provide an indication to the crew anytime power from non-rechargeable batteries has been used, in which case mandatory replacement is required.
    - iii. The backup battery must be replaced or tested on a periodic basis.
    - iv. Backup battery systems using rechargeable batteries must meet TSO-C173a / RCTA DO-293A for lead acid and ni-cad batteries and be approved for installation in a manner acceptable to the FAA.
    - v. Backup battery systems using rechargeable lithium batteries must meet TSO-C179b / RTCA DO-311A. Lithium battery installation must be approved by STC.
    - vi. Backup battery systems using non-rechargeable lithium batteries must meet TSO C-142b / RTCA DO-227A. Lithium battery installation must be approved by STC.
  - b. **FAA Approved Factory Dual Electrical Systems:** The second SIM must be connected to the second battery on aircraft factory equipped with dual electrical systems and dual batteries. The following requirements must also be met:
    - i. The batteries must be isolated from each other in a means that prevents a failure of one battery effecting the second battery.
    - ii. The second battery must provide the flight crew a pre-flight method of ensuring sufficient capacity is available to power the second SIM for a minimum of 60 minutes.
7. **For Twin Engine Aircraft:** the second SIM of each engine must be connected to a dedicated FAA Approved Backup Battery System (that each conforms to the requirements in Section 2.2.6.a. above) for each engine. The second SIM of each engine may not share a second battery or a FAA Approved Backup Battery System.
8. An alternator or generator in an electrical system is not to be considered a source of power for a SIM.

## 2.3. Component List:

The following items are needed to install the SIM to an engine. They should be included in the box:

1. SureFly Ignition Module: SIM6C,
2. SIM6C Hardware Kit. See drawing SIM6C-HW for contents of kit,
3. These installation instructions: SF1003.

If any documents are missing, you may find copies at [www.surefly.aero/engine](http://www.surefly.aero/engine)

Please contact SureFly if any items are found damaged.

## 2.4. Preparation:

**READ AND UNDERSTAND ALL OF THE INSTRUCTIONS BEFORE BEGINNING INSTALLATION.**

a) Familiarize yourself with the terminals and ports of the SIM:

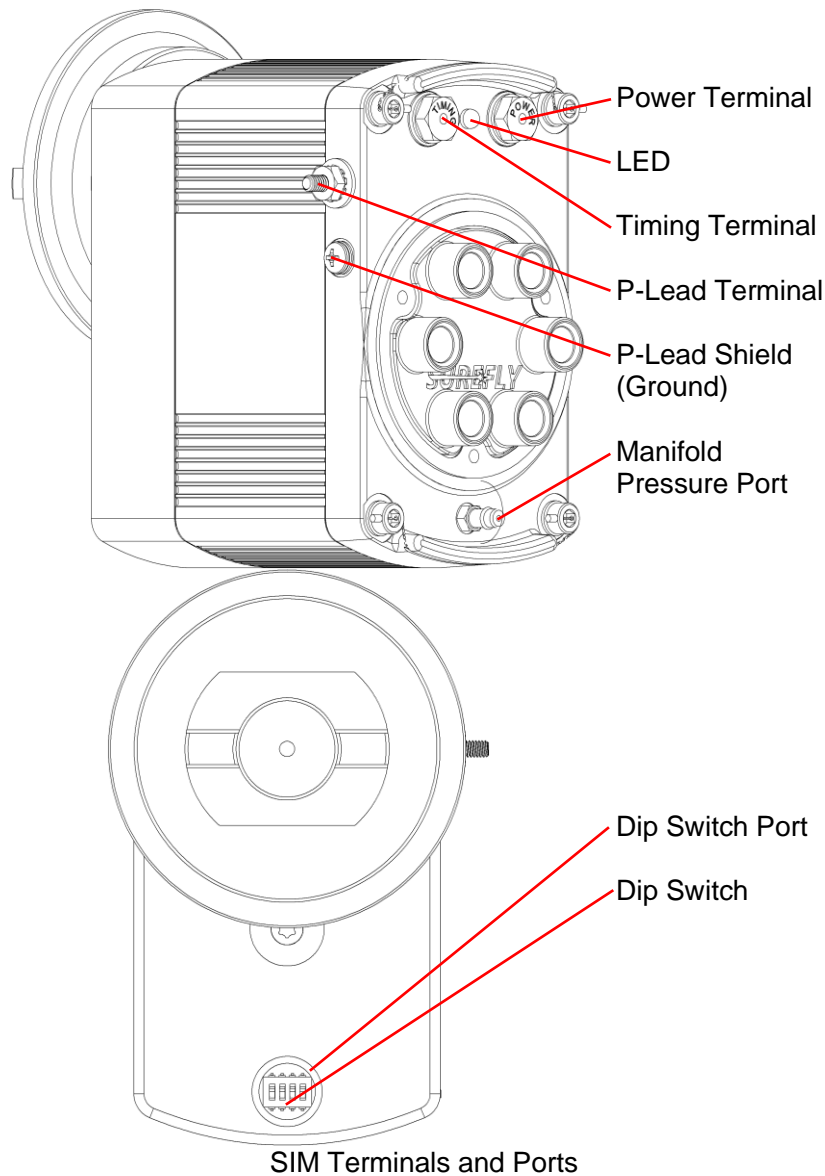

## 2.5. Remove Magneto:

- a) Remove one spark plug from #1 cylinder.
- b) Label the running p-lead wire connected to the magneto being replaced.
- c) Remove the existing ignition harness by removing the screws securing the cap to the magneto.
- d) Remove p-lead and ground (if present) from magneto being replaced.
- e) Remove magneto from engine by removing the nuts, washers and clamps securing it to the engine. Some of this hardware will be re-used to install the SIM.
- f) Remove the magneto gasket and clean the engine mounting surface.

## 2.6. Remove & Inspect Drive Interface:

- a) Remove the magneto drive interface by gently and carefully pulling it out of the engine magneto cavity.
- b) Inspect drive gear per manufacturer's recommendations.
- c) If drive gear is out of specifications, discard and replace with an airworthy drive gear and proceed.
- d) If drive gear is within manufacturer's specifications, proceed.
- e) If magneto drive cushions or retainer are out of specification, discard and replace with new and proceed.
- f) If magneto drive cushions and retainer are within manufacturer's specifications, proceed.
- g) SureFly recommends replacing both drive cushions with new at this stage, regardless of condition.

















## 2.7. Configure SIM:

- a) Find the data-plate on the engine and note the timing value listed for the magneto being replaced.
- b) Record the timing value here: \_\_\_ ° Before Top Dead Center (BTDC).
- c) The SIM6C needs to be configured for rotational direction. **The rotational direction of the magneto being replaced can be found in its part number or on its data plate.** Please note: L or R in this step does not correlate to left or right install position of the SIM on the engine, nor the rotation of the engine/magneto drive gear. **The SIM will not run the engine if configured incorrectly at this stage.** Please call SureFly at 817-373-5161 if unable to confirm rotation of magneto being removed.

Record the rotational direction of the magneto being replaced here: \_\_\_\_\_



- d) Find the matching engine timing value in the table below. Move across the row matching rotation and whether the SIM is to operate in variable or fixed timing mode to find the appropriate dip switch setting.

Engine Timing	Ignition Rotation	Timing Mode	Switch Positions				DIP Switch	LED Code
			1	2	3	4		
20°	Left(L)(LN)	Variable	OFF	OFF	OFF	OFF		— — — —
	Left(L)(LN)	Fixed	OFF	ON	OFF	OFF		— — — —
	Right(R)(RN)	Variable	ON	OFF	OFF	OFF		- - - - -
	Right(R)(RN)	Fixed	ON	ON	OFF	OFF		- - - - -
22°	Left(L)(LN)	Variable	OFF	OFF	OFF	ON		— — — —
	Left(L)(LN)	Fixed	OFF	ON	OFF	ON		— — — —
	Right(R)(RN)	Variable	ON	OFF	OFF	ON		- - - - -
	Right(R)(RN)	Fixed	ON	ON	OFF	ON		- - - - -
24°	Left(L)(LN)	Variable	OFF	OFF	ON	OFF		— — — —
	Left(L)(LN)	Fixed	OFF	ON	ON	OFF		— — — —
	Right(R)(RN)	Variable	ON	OFF	ON	OFF		- - - - -
	Right(R)(RN)	Fixed	ON	ON	ON	OFF		- - - - -
26°	Left(L)(LN)	Variable	OFF	OFF	ON	ON		— — — —
	Left(L)(LN)	Fixed	OFF	ON	ON	ON		— — — —
	Right(R)(RN)	Variable	ON	OFF	ON	ON		- - - - -
	Right(R)(RN)	Fixed	ON	ON	ON	ON		- - - - -

- e) Record the derived dip switch setting and its LED code identifier here:

Dip Switch Setting:			
1	2	3	4
LED Code:			

- f) Unscrew the dip switch port plug and set it aside.  
g) Using a pick or small screwdriver, carefully reach into the dip switch port on the SIM and set the dip switch to match the setting recorded above.  
h) The word “ON” is printed on the DIP switch to identify the switch direction of ON.  
i) After setting the SIM dip switch, double check that the switch reflects the setting recorded in e) above.  
j) Apply medium strength thread-locking compound (Loctite® 242 or similar) to the threads of the plug and screw it into the dip switch port. Torque the plug to 20±2 inch-lbs.

## 2.8. Set Engine to #1 TDC:

- a) Rotate the engine to find top dead center (TDC - 0°) of #1 cylinder on the compression stroke per engine OEM instructions.

## 2.9. Install Drive Interface:

- a) Clean the drive interface of debris.
- b) Install the drive interface in the same manner it was removed from the engine as described in 2.6.
- c) Engage the magneto drive gear teeth into the engine gear teeth so that the magneto drive cushions align as close to vertical as possible.
- d) The SIM's final mounting orientation is largely determined by the orientation of the magneto drive cushions. The drive gear teeth may have to be skipped over the engine gear teeth to accommodate a better SIM mounting orientation.

## 2.10. Internally Time SIM:

- a) You must internally time the SIM to align the shaft before installing the SIM into the engine.
- b) Connect a temporary source of positive (+) 8.5 – 30VDC power (example: aircraft battery, 9V battery, DC power supply) to the terminal labelled TIMING on the SIM using the provided screw. Finger tighten the screw.
- c) Ground the SIM to the negative (-) lead of the temporary power source. Do not attempt to ground through painted or anodized surfaces – ground through the machined mount face, p-lead shield terminal or case bolt heads.

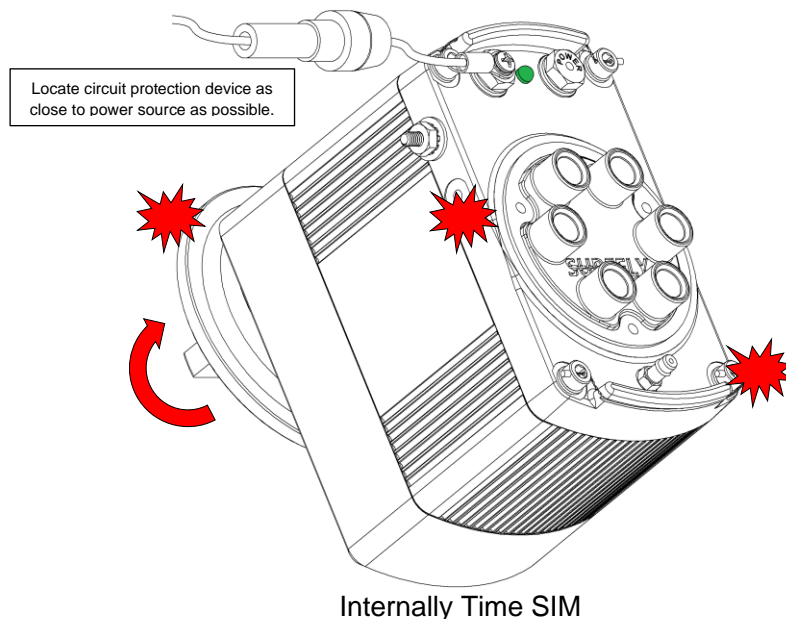

- d) The SIM LED should illuminate green. If not, wiggle the shaft, re-ground the SIM and ensure the SIM p-lead terminal is not grounded.
- e) **The SIM LED will not turn on if the p-lead terminal is grounded.**
- f) Slowly rotate the SIM shaft to find the point where the LED extinguishes.
- g) **TURN SLOWLY – the LED alignment point has a ½° window and is difficult to see if turning fast!**
- h) **It takes 1-½ turns of the SIM shaft to make 1 internal rotation.**
- i) The point at which the LED extinguishes is the SIM's internal TDC alignment.

- j) Once this point is found, care should be taken to avoid any rotation of the SIM shaft during further steps of engine installation.

## 2.11. Mount SIM to Engine:

- a) The SIM operates by syncing its internal TDC alignment point to #1 cylinder compression stroke (TDC – 0°) and advances timing within the unit based on its dip switch setting.
- b) **Confirm the engine is at top dead center (TDC - 0°) of #1 cylinder on the compression stroke.**
- c) Ensure SIM gasket is present, free of debris and seated correctly on the SIM mounting face.
- d) Ensure the SIM is still internally timed as described in 2.9.d) above.
- e) **Without allowing the SIM shaft to rotate**, align the SIM shaft blades with the magneto drive cushions and slide the SIM into the magneto cavity. Ensure the SIM shaft blades seat correctly within the magneto drive cushions.
- f) Holding the SIM flush to the engine, clock the SIM to ensure the LED extinguished point is within the rotational sweep limits of the SIM.
- g) Repeat step 2.9.d) if unable to find the LED extinguished point as the magneto drive gear may have to be skipped over a tooth in either direction.
- h) Install clamps, flat washers, lock washers & nuts on to the engine studs over the SIM's mounting flange. Do not re-use lock washers – install NEW lock washers.
- i) Finger tighten the nuts, barely allowing the SIM to rotate by hand.
- j) Clock the SIM to ensure the LED stays extinguished.
- k) At this point the SIM is timed (synced) to the engine.
- l) Torque the mounting nuts to 100 – 120 inch-lbs ensuring the LED stays extinguished.

## 2.12. SIM Timing Check:

- a) Turn the engine counter to normal rotation 1/8 of a turn from #1 cylinder TDC.
- b) Slowly rotate the engine in the normal direction.
- c) If the LED extinguishes more than 2° before or after #1 cylinder TDC, the SIM is incorrectly timed and is not in sync with the engine. Loosen the SIM mounting nuts and re-clock the SIM per 2.11.
- d) If the **LED extinguishes as #1 cylinder reaches TDC – 0°** (compression stroke) the SIM is correctly timed (synced) to the engine.
- e) Remove the temporary source of power from the TIMING terminal.

## 2.13. Install Ignition Harness:

- a) The SIM is designed to use a “Slick” style ignition harness.
- b) If replacing a “Slick” magneto, the existing harness may be re-used.
- c) If replacing any other magneto, or for a new installation, an approved “Slick” style ignition harness is needed.
- d) Although not required, SureFly recommends installing a new harness when installing a SIM.
- e) Confirm the correct harness is being used and is free of defects.
- f) Install the harness onto the SIM using the provided screws.
- g) Torque the screws to 18±2 inch-lbs.

## 2.14. Manifold Pressure Connection:

- a) The SIM **does not require** a connection to the engine's manifold pressure (MAP) to operate in **fixed timing**.
- b) If installed in fixed timing, leave the manifold pressure port on the SIM open to atmosphere and skip to the next section.
- c) The SIM **requires** a connection to the engine's manifold pressure to operate in **variable timing**.
- d) If installed in variable timing, connect the SIM manifold pressure port to engine manifold pressure using the included 1/8" ID hose.
- e) Recommended connection points to engine manifold pressure include:
  1. An unused fuel injector port on a cylinder head using an appropriate barbed hose fitting, or
  2. An unused fuel primer port on a cylinder head using an appropriate barbed hose fitting, or
  3. Tie into existing manifold pressure gauge plumbing using an appropriate barbed hose T-fitting, or
  4. Along the intake track at an unused port using an appropriate barbed hose fitting.
- f) Connect one end of the manifold pressure hose to the barbed fitting at the engine manifold pressure connection point.
- g) Route (cut shorter if needed) and connect the other end of the hose to the barbed manifold pressure port on the SIM.
- h) Secure the hose along its route being sure not to pinch, kink or impede airflow.

## 2.15. Turbocharged, Turbo-normalized or Supercharged Engines:

- a) The SIM must be installed in fixed timing mode. Verify the SIM is configured to fixed timing as per Section 2.7 of this manual.
- b) The SIM does not require pressurization.
- c) **Do not leave the pressurization line open to atmosphere.**
- d) If you are replacing a magneto that was pressurized, cap the pressurization line with appropriate fittings.
- e) Check for correct operation of the engine pressurization system by performing a pressurized magneto pressure test per engine OEM instructions.

## 2.16. Wiring:

- a) Connect positive (+) 8.5 – 30VDC power to the POWER terminal of the SIM(s) using the provided screw. Tighten the screw to 10±2 inch-lbs.
- b) Install the p-lead wire onto the SIM(s) p-lead terminal. Thread provided nut over SIM p-lead terminal. Back p-lead base nut with a wrench and torque the nut to 15±2 inch-lbs.
- c) If the p-lead wire is shielded, connect the shield to the p-lead shield (ground) terminal with the provided screw and torque to 15±2 inch-lbs.

## 3. Post-Installation

### 3.1. Spark Plugs & Harness:

- a) Inspect all spark plugs connected to the SIM. Gap all spark plugs connected to the SIM, SureFly recommends a spark plug gap of 0.022" – 0.035".
- b) Re-install spark plugs and torque to manufacturer's specifications.
- c) Connect ignition harness to spark plugs ensuring all wires are routed to the correct cylinders. Torque to manufacturer's specifications.

### 3.2. Final Inspection:

- a) Visually inspect the following items:
  1. SIM mounting hardware present and torqued,
  2. Power wire is connected and secure at SIM power terminal,
  3. Ignition harness and spark plugs installed and torqued,
  4. Manifold pressure hose secure at MAP source and SIM MAP terminal,
  5. All wires, hoses and harnesses are properly secured along their entire route.

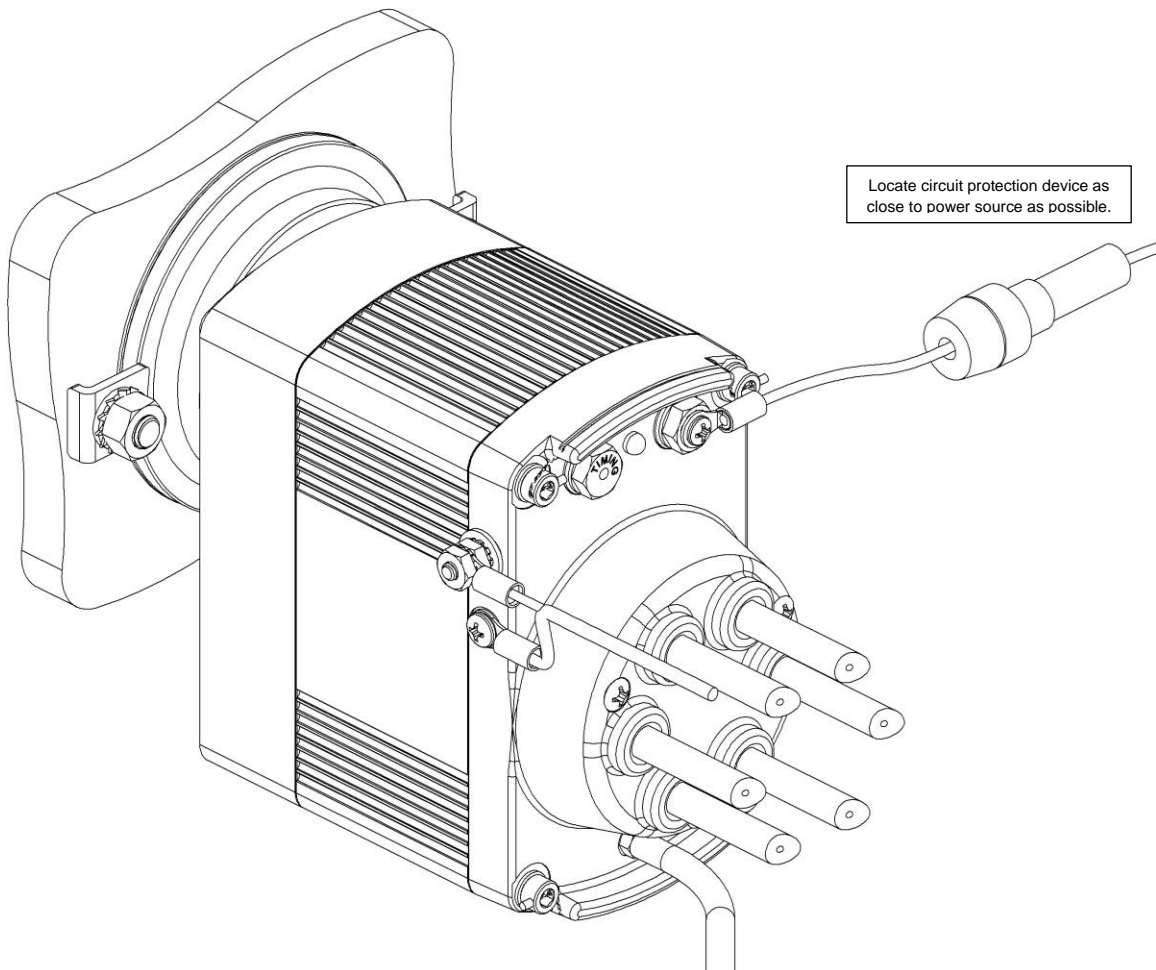

Typical SIM6C Installation

### 3.3. Pre-Operational Check:

- a) Ensure the ignition switch is turned off (p-lead grounded).
- b) Clear the propeller area.
- c) Turn the ignition switch on (p-lead un-grounded) and verify SIM LED illuminates and blinks.
- d) The SIM LED will blink the code set by the SIM dip switch. The code will repeat for 4 cycles before the LED goes inactive. Cycle the ignition switch to see the LED code again.
- e) Verify the code blinked by the SIM LED matches the code recorded in 2.7.
- f) The code must exactly match the intended SIM timing setting. If the code differs, remove the SIM and start over from 2.7.
- g) If the LED blinks rapidly at 12 blinks/second, stop and contact SureFly.

### 3.4. Operational Check:

- a) Start the engine normally using the engine manufacturer's recommended starting procedure.
- b) Contact SureFly if the engine does not run, or does not run smoothly on the SIM.

### 3.5. Airframe Installation & Electrical Power:

See SureFly's Airframe Installation Instructions SF2001 for guidance on installing a SIM-modified engine into an airframe and for connecting electrical power to a SIM. For information on SureFly's airframe STC please see [www.surefly.aero/airframe](http://www.surefly.aero/airframe)

---

## 4. Documentation

---

### 4.1. STC Permission Letter:

- a) You must obtain a letter of permission from SureFly Partners, LTD before completing the engine STC.
- b) Please visit [www.surefly.aero/engine](http://www.surefly.aero/engine) to view and print a copy of SureFly's STC permission letter.

### 4.2. FAA Form 337:

- a) You must file a FAA Form 337 to notify the FAA of the alternation to the engine in accordance with SureFly's engine STC, engine AML, engine ICA and these Installation Instructions.
- b) Please visit [www.surefly.aero/engine](http://www.surefly.aero/engine) to view and print a copy of SureFly's engine STC documents.

### 4.3. Maintenance Log:

- a) You must document the alteration to the engine in the engine's maintenance records and/or logbooks.

### 4.4. ICA:

- a) SureFly document SF1005, Instructions for Continued Airworthiness may be found at [www.surefly.aero/engine](http://www.surefly.aero/engine)